

# Relays with coil continuity test, monostable and bistable

2.07

## RMN • RMD SERIES

### OVERVIEW

- Plug-in relay with coil continuity self-test feature, in monostable and bistable versions
- Solid and rugged construction for heavy or intensive duty
- Very high electrical life expectancy and notable endurance
- Self-cleaning knurled contacts
- Fitted with mechanical optical contact status indicator as standard
- Lever for manual operation (optional)
- Operation using d.c. or a.c. power supply
- Wide variety of configurations and customizations
- Transparent cover, fixing/pulling screws
- Label holder in cover for customer's use
- Positive mechanical keying for relay and socket

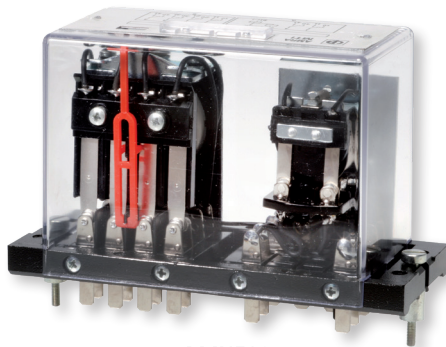

RMNE16

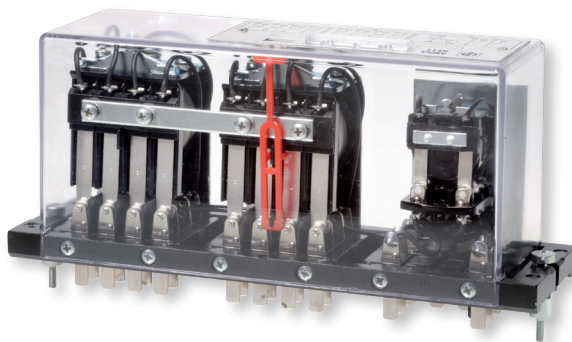

RMNE17

### APPLICATIONS



Shipbuilding



Petroleum industry



Heavy industry



Power generation



Power distribution



Railway equipment

## DESCRIPTION

Relays of the RMN (MONOSTABLE) and RMD (BISTABLE) series are equipped with a function for testing the continuity of the coil. The coils of the main relay can be monitored by a built-in auxiliary relay, which indicates the readiness of the main relay to perform the next operation, that is to say by physically testing the continuity of the coils. The effect is to create a system for supervising and monitoring the relay, and determining whether or not it is still operational. There are two ways of monitoring continuity of the coils: Periodic test (accomplished by pressing an external button, installed by the customer) or Continuous check (RMN series only, by way of an external switch installed by the customer).

RMN and RMD relays are derived from the G series, and offer the same specifications and performance. The mechanical design of the relay is such as to allow the development of numerous custom solutions, in the event that the standard models do not fully respond to the required performance parameters. A built-in mechanical optical indicator monitors the status of the relay; a manual operating lever (optional) allows the contacts to be switched by hand.

The contacts used are of a type designed to give good levels of performance both with high and strongly inductive d.c. loads, and with particularly low loads such as interface signals; inclusion of the magnetic arc blow-out function (RMN) helps to achieve a considerable increase in breaking capacity. Knurled contacts ensure not only better self-cleaning characteristics, but also lower ohmic resistance thanks to multiple points of electrical connection, thereby extending the electrical life expectancy of the component.

Typical sectors of use are among the most demanding, such as, for example, electricity generating stations, electrical transformer stations, fixed equipment for railways, or industries using continuous production processes (chemical and petrochemical, rolling mills, cement factories, etc.). The performance and reliability of the product have secured its approval with ENEL and other multi-utilities.

Like all AMRA relays, models of the series with coil continuity test are assembled as part of a controlled manufacturing process in which every step of production is verified by the next step in succession. In effect, each relay is calibrated and tested individually, by hand, in such a way as to guarantee top reliability.

Models	Monostable	Bistable	Number of contacts		Magnetic arc blow-out
			main	diagnostics	
RMN.x6	•		4	2	•
RMN.x7	•		8	2	•
RMN.x9	•		16	2	•
RMD.x1		•	4	2	
RMD.x2		•	8	2	
RMD.x4		•	16	2	

**FOR CONFIGURATION OF PRODUCT CODE, SEE "ORDERING SCHEME" TABLE**

Coil data	RMN.x6	RMN.x7-x9	RMD.x1	RMD.x2-x4
Nominal voltages Un	DC/AC : 12-24-48-110-125-132-144-220 AC : 230-380-440 <sup>(1-2)</sup>		DC : 12-24-48-110-125-132-144-230 <sup>(1)</sup>	
Consumption at Un (DC/AC)	3W / 6.5VA <sup>(3)</sup> - 11.5VA <sup>(4)</sup>	6W / 15VA <sup>(3)</sup> - 25VA <sup>(4)</sup>	15W <sup>(5)</sup>	30W <sup>(5)</sup>
Operating range	DC: 80...120% Un - AC: 85...110% Un			
Type of duty	Continuous			
Drop-out voltage <sup>(6)</sup>	DC : > 5% Un - AC : > 15% Un		-	

For bistable versions: minimum control pulse: 100 ms

(1) Other values on request.

(2) Maximum value, a.c., = 380V 50Hz - 440V 60Hz.

(3) In operation.

(4) On pick-up.

(5) During latch and unlatch. Power consumption is zero on completion of the operating cycle, as the coil de-energizes automatically.

(6) Limit value for supply voltage, expressed as % of the nominal value, beneath which the relay is certain to be de-energized.

**Contact data**

Number and type	4 - 8 - 16 SPDT, form C (main relay) + 2 SPDT, form C (diagnostics relay)					
Current	Nominal <sup>(1)</sup>	10A (main contacts) - 5A (diagnostics contacts)				
	Maximum peak <sup>(2)</sup>	20A for 1min - 40A for 1s (main contacts)				
	Maximum pulse <sup>(2)</sup>	150A for 10ms (diagnostics contacts)				
Example of electrical life expectancy <sup>(3)</sup>	RMN.x6-x7-x9 : 1A - 110Vdc - L/R 40ms - 10 <sup>5</sup> operations - 1,800 operations/hour RMD.x1-x2-x4: 0.5A - 110 Vdc - L/R 40ms - 10 <sup>5</sup> operations - 1,800 operations/hour diagnostics contacts: 0.2A - 110 Vdc - L/R 40ms - 10 <sup>5</sup> operations - 1,800 operations/hour					
Minimum load	Standard contacts	200mW (10V, 10mA)				
	Gold-plated contact	50mW (5V, 5mA)				
Maximum breaking voltage	350 VDC / 440 VAC					
Contact material	AgCdO					
Operating time at Un (ms) <sup>(4)</sup>	RMN.x6	RMN.x7	RMN.x9	RMD.x1	RMD.x2	RMD.x4
	DC - AC	DC - AC	DC - AC	DC	DC	DC
Pick-up (NC contact opening)	≤ 16 - ≤ 11	≤ 14 - ≤ 11	≤ 15 - ≤ 12	≤ 10	≤ 10	≤ 10
Pick-up (NO contact closing)	≤ 42 - ≤ 33	≤ 39 - ≤ 37	≤ 38 - ≤ 33	≤ 30	≤ 30	≤ 30
Drop-out (NO contact opening)	≤ 13 - ≤ 31	≤ 13 - ≤ 31	≤ 10 - ≤ 28	≤ 10	≤ 10	≤ 10
Drop-out (NC contact closing)	≤ 66 - ≤ 114	≤ 70 - ≤ 83	≤ 45 - ≤ 74	≤ 40	≤ 40	≤ 40

(1) On all contacts simultaneously, reduction of 30%.

(2) Maximum peak and pulse currents are those currents that can be handled, for a specified time, by the contact. They do not refer to steady or interrupted currents.

(3) For other examples, see electrical life expectancy curves.

(4) Unless specified otherwise, operating times are understood as comprising stabilization of the contact (inclusive of bounces).

**Insulation**

Insulation resistance (at 500Vdc)	
between electrically independent circuits and between these circuits and ground	> 10,000 MΩ
between open contact parts	> 10,000 MΩ
Withstand voltage at industrial frequency	
between electrically independent circuits and between these circuits and ground	2 kV (1 min.) - 2.2kV (1 s)
between open contact parts	2 kV (1 min.) - 2.2kV (1 s) <sup>(1)</sup>
between adjacent contacts	2 kV (1 min.) - 2.2kV (1 s)
Impulse withstand voltage (1.2/50μs - 0.5J)	
between electrically independent circuits and between these circuits and ground	5 kV
between open contact parts	5 kV <sup>(1)</sup>

(1) 1kV for auxiliary relay for coil continuity check.

Mechanical specifications		RMN.x6 - RMD.x1	RMN.x7 - RMD.x2	RMN.x9 - RMD.x4
Mechanical life expectancy		20x10 <sup>6</sup> operations		
Maximum switching rate	Mechanical	3600 operations/hour for monostable version - 900 operations/hour for bistable version		
Degree of protection		IP40		
Dimensions (mm)		132x58x84 <sup>(1)</sup>	188x58x84 <sup>(1)</sup>	300x58x84 <sup>(1)</sup>
Weight (g)		460	770	1150

(1) Output terminals excluded.

Environmental specifications	
Operating temperature	-25 to 55°C
Storage and shipping temperature	-25 to 70°C
Relative humidity	Standard : 75% RH - Tropicalized : 95% RH
Fire behaviour	V0

Standards and reference values	
EN 61810-1, EN 61810-2, EN 61810-7 EN 60695-2-10 EN 50082-2 EN 60529	Electromechanical elementary relays Fire behaviour Electromagnetic compatibility Degree of protection provided by enclosures

Unless otherwise specified, products are designed and manufactured according to the requirements of the European and International standards indicated above.  
In accordance with EN 61810-1, all items of technical data are referred to ambient temperature 23 °C, atmospheric pressure 96kPa and 50% humidity.  
Tolerance for coil resistance, nominal electrical input and nominal power is ±7%.

Configurations - Options	
TROPICALIZATION	Surface treatment of the coil with protective coating for use with RH 95%.
GOLD PLATING	Surface treatment of contacts, blades and output terminals with gold-cobalt, thickness ≥2μ. This treatment ensures long-term capacity of the contact to conduct lower currents.
LEVER FOR MANUAL OPERATION	Allows manual operation of the relay, with the cover closed, using a screwdriver.

Ordering scheme							
Product code	Application <sup>(1)</sup>	Configuration A	Configuration B	Type of power supply	Nominal voltage (V) <sup>(2)</sup>	Finish <sup>(3)</sup>	Keying position code <sup>(4)</sup>
RMN	E: Energy F: Railway Fixed Equipment	1: Standard 4: Gold plating	6: 4 SPDT contacts with magnetic arc blow-out 7: 8 SPDT contacts with magnetic arc blow-out 9: 16 SPDT contacts with magnetic arc blow-out	C: Vdc A: Vac 50 Hz H: Vac 60 Hz	012 - 024 - 048 110 - 125 - 132 144 - 220 - 230 380 - 440	T: Tropicalized coil  M: Manual operation <sup>(5)</sup>	xxx
RMD			1: 4 SPDT contacts 2: 8 SPDT contacts 4: 16 SPDT contacts	C: Vdc	012 - 024 - 048 110 - 125 - 132 144 - 220		

Example	RMN	E	4	7	A	024	M	
	RMNE47-A024/M = ENERGY series monostable relay with coil continuity test, 8 gold-plated contacts, magnetic arc blow-out, 24Vac coil and manual operating lever.							
	RMD	F	1	4	C	110		OVH
RMDF14-C110-OVH = RAILWAY series bistable relay with coil continuity test, 16 standard contacts, 110Vdc coil and mechanical keying position OVH.								

(1) ENERGY: all applications except for railway.

RAILWAYS, FIXED EQUIPMENT: application on fixed power systems and electrical railway traction. For list of RFI compliant and type-approved products, consult dedicated catalogue "RAILWAY SERIES – RFI APPROVED".

(2) Other values on request. Voltages 380V and 440V available as Vac only.

(3) Optional value. Multiple selection possible (e.g. TM).

(4) Optional value. Positive mechanical keying is applied according to the manufacturer's product model.

(5) With manual operation, no optical indicator.

**Wiring diagram**

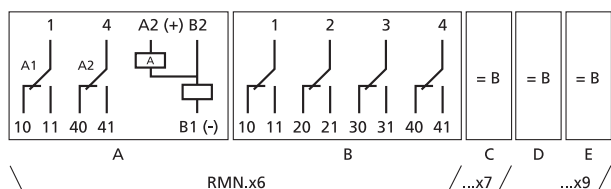

RMN.xy

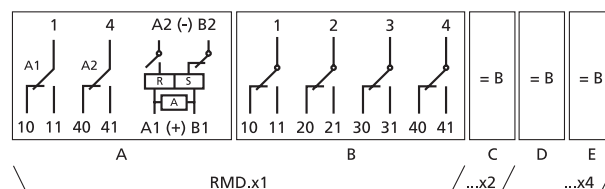

RMD.xy

**NOTE:**  
 Coils nomenclature change from 2024/05  
**S** = SET (it was C)  
**R** = RESET (it was S)

**Self-diagnostics**

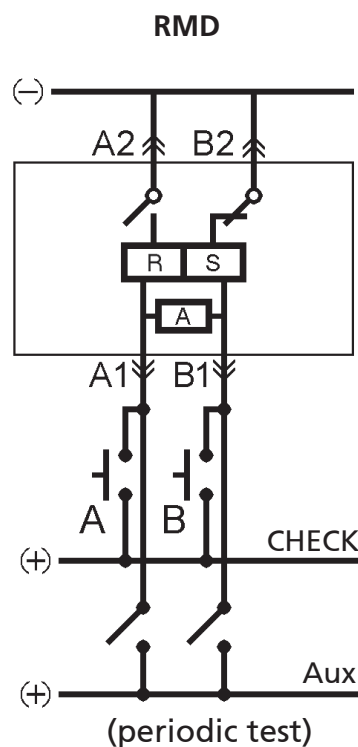
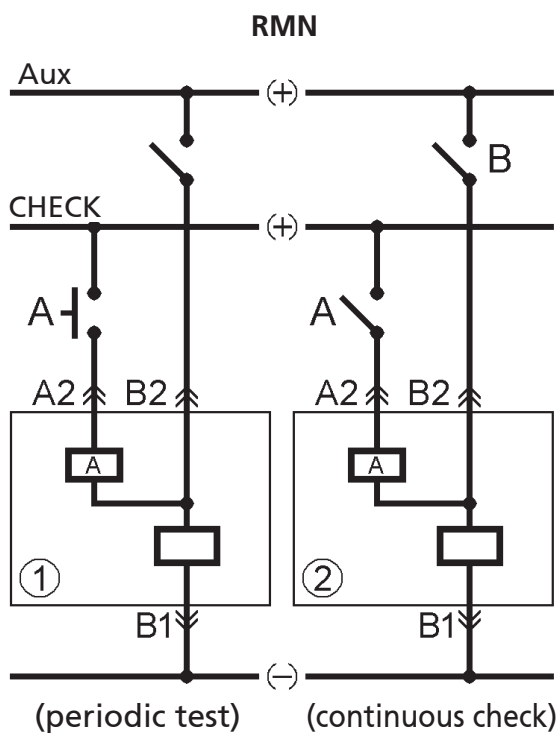

**Self-diagnostics function:** The main coil is monitored by a monostable relay (A) that indicates when the relay is ready to perform the next operation. Two monitoring methods are possible: 1) Coil tested periodically by pressing button "A". 2) Coil checked continuously by way of contact "A". Following activation of the relay, the reset is accomplished by opening both contacts "A" and "B".

**Self-diagnostics function:** The latch (S) and unlatch (R) coils are monitored by a monostable relay (A) that indicates when the relay is ready to perform the next operation. Only periodic testing of the coils is possible. Coil (S) is tested by means of button "A", and coil (R) by means of button "B". Note: The contacts of the two buttons "A" and "B" must never be closed simultaneously.

## Dimensions

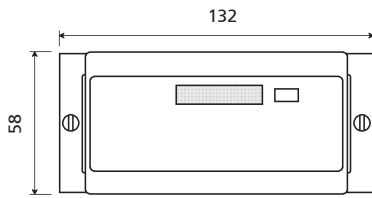

RMN.x6, RMD.x1

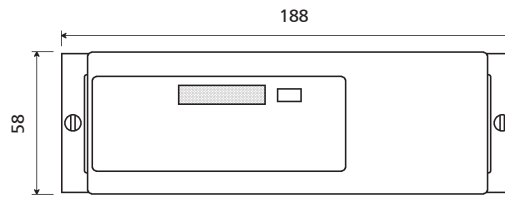

RMN.x7, RMD.x2

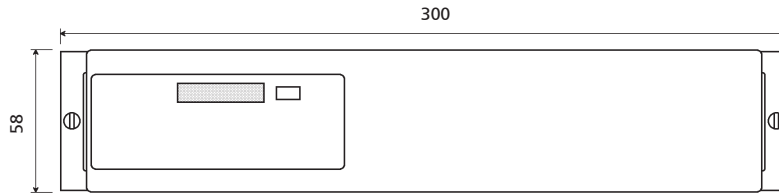
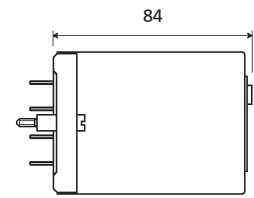

RMN.x9, RMD.x4

## Electrical life expectancy (main contacts)

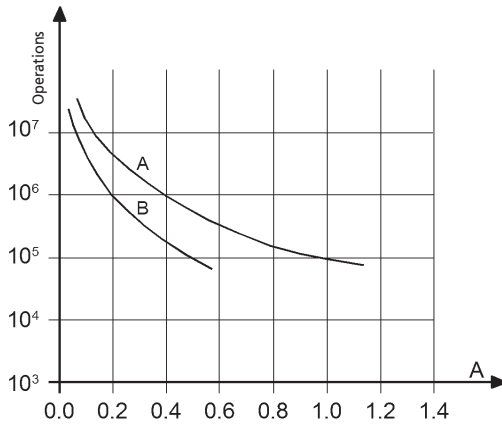

Contact loading: 110Vdc, L/R 40 ms  
Curve A: RMN\_xy  
Curve B: RMD\_xy

RMN			
U	I (A)	L/R (ms)	Operations
24Vdc	1	0	7,000,000
24Vdc	1	40	3,000,000
24Vdc	2	40	2,000,000
24Vdc	5	0	3,000,000
24Vdc	5	40	200,000
24Vdc	9	0	800,000
48Vdc	5	20	200,000
110Vdc	0.4	40	1,000,000
110Vdc	1	40	100,000
110Vdc	10	0	100,000
U	I (A)	cosφ	Operations
220Vac	5	0.5	100,000
220Vac	10	1	100,000
230Vac	1	0.7	2,500,000
230Vac	3	0.7	1,200,000

RMD			
U	I (A)	L/R (ms)	Operations
110Vdc	0.5	40	100,000
110Vdc	0.6	10	300,000
120Vdc	0.7	40	100,000
125Vdc	1.2	0	1,000,000
220Vdc	0.1	40	100,000
220Vdc	0.25	10	100,000
U	I (A)	cosφ	Operations
110Vac	1	1	2,000,000
110Vac	1	0.5	1,500,000
110Vac	5	1	1,000,000
110Vac	5	0.5	500,000
220Vac	0.5	1	2,000,000
220Vac	1	0.5	600,000
220Vac	5	1	650,000
220Vac	5	0.5	600,000

Switching frequency: 1,200 operations/hour

## Sockets and retaining clips

Type of installation	Type of outputs	RMN.x6 - RMD.x1	RMN.x7 - RMD.x2	RMN.x9 - RMD.x4
Wall or DIN H35 rail mounting	Screw	PAVM321	PAVM481	PAVM801
Flush mounting	Double faston (4.8 x 0.8 mm)	PRDM321	PRDM481	PRDM801
	Screw	PRVM321	PRVM481	PRVM801

Installation

Before installing the relay on a wired socket, disconnect the power supply.

The preferential mounting position is on the wall, with the relay positioned horizontally in the "reading orienting" of marking so that the label is readable in the correct sense.

**Spacing:** these relays can be mounted without distance between one relay and the next.

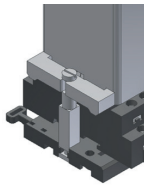

**Mounting of the relay on the socket:**

the relays are equipped at their ends with 2 screws that allow to obtain the correct insertion in the socket and to hold the relay in the correct mounting position.

Place the relay against the socket, making a slight pressure to center the relay terminals over the socket terminals. Screw the two screws progressively and alternately, moving the relay evenly towards the socket.

Avoid screwing/unscrewing completely one screw and then the other one.

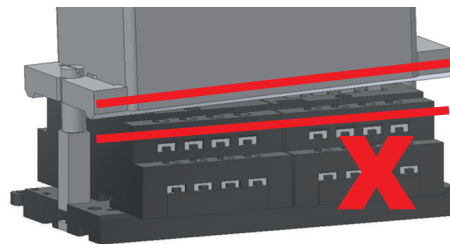
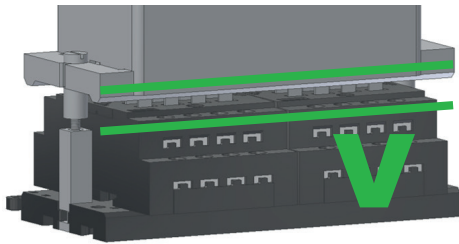

Operation

Before use: if relay is not used, for example after long storage periods, contact resistance may increase due to a natural and slight oxidation or polluting deposits.

In order to restore the optimal conductivity and for standard contacts (NOT gold plated) it is recommended to switch several time a load of at least 110Vdc - 100mA or 24Vdc - 2A. The contacts will be "cleaned" thanks to the electric arc generated during the current interruption and the mechanical self-cleaning action.

The common contact rubs against the fixed poles (NO and NC contacts) both when opening and when closing, which ensures a self-cleaning action.

An increase in contacts' resistance, in most cases, does not represent a problem. Many factors contribute to the correct use of contact and consequently to the relay' long-term reliability:

- **Load:** the current switching generates an electric arc with cleaning effects. For proper electrical cleaning and performance keeping we recommend:
  - o Standard contacts: Minimum current = 20mA (20V)
  - o Gold plated contacts: Minimum current = 10mA (20V)
- **Operating frequency:** relays are components that can operate with a wide range of switching frequency. High frequency operation also allows a continuous cleaning effect by "sliding" (mechanical cleaning). In case of low frequency operation (for example few time a day), we advise:
  - o Use of contact with currents twice compared to those indicated.
  - o For currents lower than 10mA, use gold plated contacts and connect 2 contacts in parallel, in order to reduce the equivalent contact resistance
- **Pollution:** the presence of pollution can cause impurities on contact surface. Electric charges attract organic molecules and impurities that are deposited on the contact surface. Electrical and mechanical cleaning, respectively, burn and remove such impurities. In pollution presence, the minimum recommended currents must be respected. In extreme cases, provide double the cleaning current.

While a contact open high loads, impurities develop inside the relay due to the formation and interruption of the electric arc. These impurities are greater the higher the load and the more frequent the switching operation. These impurities could deposit on the adjacent contacts and alter the initial conductivity characteristics. If all contacts are used with similar loads, this is not a problem.

Please, contact AMRA for further informations.

Condensation is possible inside the relay when energized and the outside ambient temperature is cold; this is quite normal and does not affect the operation of the relay. Plastic materials of relay do not possess hygroscopic properties.

## Maintenance

No maintenance is required.

In case of normal relay wear (reaching the end of electrical or mechanical life), the relay cannot be restored and must be replaced.

### **Unmounting of the relay from the socket:**

as for the installation, it is necessary to unscrew the relay on the 2 anchor screws of the product in a progressive and alternating way, extracting the relay evenly from the socket.

Avoid screwing/unscrewing completely one screw and then the other one.

Often the malfunctions are caused by power supply with inverted polarity, by external events or by use with loads exceeding the contact performance.

In case of suspected malfunction, energize relay and observe if mechanical operation of contacts / relay mechanism is performed. Pay attention to the power supply polarity, if relay is equipped with polarized components (example: diode, led).

- In case of expected operation, clean the contacts (see paragraph "OPERATION") and check if the circuit load ranges within the contact performance. If necessary, replace with relays with gold contacts. Note: the electrical continuity of contacts must be checked with adequate current.
- If it does not work, we recommend to use a relay of the same model and configuration.

If an investigation by AMRA is required, pull-out the relay from the socket, don't remove the cap, avoid any other manipulation and contact us. You will be asked for the following data: environmental conditions, power supply, switching frequency, contact load, number of operations performed.

The fault can be described through the "TECHNICAL SUPPORT" section of the website [www.amra-chauvin-arnoux.it](http://www.amra-chauvin-arnoux.it).

In any case, the relay cannot be repaired by the user.

## Storage

Storage conditions must guarantee the environmental conditions (temperature, humidity and pollution) required for the product conservation, in order to avoid deterioration.

The product must be stored in an environment sheltered from atmospheric agents and not polluted, with an ambient temperature between -25 and +70°C with max 75% RH. Humidity can reach peaks of 95%. In any case, there must be no condensation. Before use, please read carefully "OPERATION" section.